

Sensor Data Streams Correlation Platform for Asthma Management

A thesis submitted in partial fulfillment
of the requirements for the degree of
Master of Science in Computer Science

by

Vaikunth Sridharan
B.Tech., Anna University, 2014

2018
WRIGHT STATE UNIVERSITY

WRIGHT STATE UNIVERSITY
GRADUATE SCHOOL

May 29, 2018

I HEREBY RECOMMEND THAT THE THESIS PREPARED UNDER MY SUPERVISION BY Vaikunth Sridharan ENTITLED Sensor Data Streams Correlation Platform for Asthma Management BE ACCEPTED IN PARTIAL FULFILLMENT OF THE REQUIREMENTS FOR THE DEGREE OF Master of Science.

Amit Sheth, Ph.D.
Thesis Director

Mateen M. Rizki, Ph.D.
Chair, Department of Computer Science and Engineering

Committee on
Final Examination

Amit Sheth, Ph.D.

Krishnaprasad Thirunarayanan, Ph.D.

Maninder Kalra, M.D. Ph.D.

Valerie Shalin, Ph.D.

Barry Milligan, Interim Dean of the Graduate School, School of Graduate Studies, Ph.D.
Dean, School of Graduate Studies

ABSTRACT

Sridharan, Vaikunth. M.S., Department of Computer Science and Engineering, WRIGHT STATE UNIVERSITY, 2018. *Sensor Data Streams Correlation Platform for Asthma Management*.

Asthma is a high-burden chronic inflammatory disease with prevalence in children with twice the rate compared to adults. It can be improved by continuously monitoring patients and their environment using the Internet of Things (IoT) based devices. These sensor data streams so obtained are essential to comprehend multiple factors triggering asthma symptoms. In order to support physicians in exploring causal associations and finding actionable insights, a visualization system with a scalable cloud infrastructure that can process multi-modal sensor data and Patient Generated Health Data (PGHD) is necessary.

In this thesis, we describe a cloud-based asthma management and visualization platform that integrates personalized PGHD from kHealth¹ kit and outdoor environmental observations from web services². When applied to data from an individual, the tool assists in analyzing and explaining symptoms using "personalized" causes, monitor disease progression, and improve asthma management. The front-end visualization was built with Bootstrap Framework and Highcharts. Google's Firebase and Elasticsearch engine were used as back-end storage to aggregate data from various sources. Further, Node.js and Express Framework were used to develop several Representational State Transfer services useful for the visualization.

¹<http://wiki.knoesis.org/index.php/Asthma>

²https://en.wikipedia.org/wiki/Web_service

Contents

1	Introduction	1
1.1	Challenges	3
1.2	Contribution	4
2	Related Work	6
2.1	Generic Studies	6
2.2	Asthma Management Specific Studies	7
3	Technologies	10
3.1	Programming Language	10
3.1.1	Microservices	11
3.2	Framework	11
3.3	Back-end Database	12
3.4	Front-end Visualization	13
3.4.1	jQuery	14
3.4.2	CSS Framework	15
3.4.3	Chart Libraries	15
3.4.4	Date-time Serialization, and Management	16
3.4.5	Utility Library	16
4	Approach	18
4.1	Data Sources and Collection	18
4.1.1	kHealth-Asthma Android Application	19
4.1.2	Wearable Sensor: Activity and Sleep	21
4.1.3	Indoor Environmental Data	22
4.1.4	Outdoor Environmental Observations	23
4.1.5	Digital Peak Flow Meter	24
4.2	Data Aggregation	25
4.2.1	Patient recorded readings	25
4.2.2	Mapping Inventory and third-party APIs	26
4.2.3	Outdoor Environmental Web-services	27
4.3	Data Modelling and Processing	28

4.3.1	Outdoor environmental data and Geo-spatial Modelling	28
4.3.2	Indoor Environmental data and Wearable data	29
4.3.3	Patient Generated Health Data (kHealth-Asthma App)	29
4.4	Data Visualization	30
4.4.1	Demonstration	32
5	Evaluation	33
5.1	Metrics	33
5.1.1	Usefulness	33
5.1.2	Usability	34
5.2	Method	34
5.3	Results	35
5.3.1	Usefulness	35
5.3.2	System Usability Scale	38
6	Discussion and Analysis	39
7	Conclusion	41
	Bibliography	42

List of Figures

1.1	Health monitoring devices and sensors in healthcare paradigm	1
1.2	Asthma symptoms caused by triggers	2
1.3	(Component-A) kHealth-Asthma kit provided to asthma participants to record readings; (Component-B) pooling sensor data from authentication-enabled third-party APIs; (Component-C) Outdoor environmental observations retrieved based on monitoring stations; (Component-D) Scalable infrastructureweb services, REST APIs, cloud storage platforms; (Component-E) kHealthDash interface provides synthesised visualization of multimodal data with clinical knowledge.	5
3.1	Node.js event loop work flow and handling intensive operations.	11
3.2	Typical Express work flow showing front-end (view), database (model) and middle-ware services, and APIs (controller)	12
3.3	Elasticsearch indices (similar to MySQL tables), documents (records or rows), offering storage, aggregations, and filtering.	13
3.4	Shows the front-end interface with supporting technologies	14
3.5	Shows Twitter’s Bootstrap CSS Framework	15
4.1	System methods showing data sources, aggregation, integration and visualization	18
4.2	The kHealth-Asthma Android App and the readings recorded by patients on a daily basis	20
4.3	Fitbit Charge 2™ that tracks activity (steps, active minutes), sleep and heart rate.	21
4.4	Foobot - Air quality monitoring sensor placed on a table indoors, showing the two important LED patterns when air quality is good or poor.	23
4.5	Data collected from outdoor monitoring stations for each observation for every hour of the day.	24
4.6	Digital Peak Flow Meter which measures peak expiratory flow, and forced expiratory volume per sec.	25
4.7	Mapping inventory schema from Elasticsearch cloud storage	26
4.8	Represents the Open Authentication-enabled workflow between a user and resource servers such as Fitbit or Foobot.	27

4.9	kHealthDash login screen, patient overview and quick-access summary displaying anecdotal instance outcomes, patient compliance, and discrepancy analysis	30
4.10	kHealthDash user-interface visualizing outdoor environmental observation versus a patient reported symptoms and medications	31
4.11	kHealthDash user-interface visualizing indoor environmental observation, activity and sleep stages versus patient recorded symptoms and medication usage.	32
5.1	(a) Shows mean score for domain experts without kHealthDash and with kHealthDash (b) t-test with p-value for domain experts for comparing the two distributions	36
5.2	(a) Shows mean score for non-domain experts without kHealthDash and with kHealthDash (b) t-test with p-value for non-domain experts for comparing the two distributions	37
5.3	Shows mean SUS score for domain and non-domain participants	38
6.1	An instance of asthma patient readings on kHealthDash interface (May 3 to May 21, 2017)	39

List of Tables

2.1	Represents prior studies, main objectives, sensors/parameters used with no patient trial/evaluation performed.	6
3.1	Shows the utility functions provided by Lodash	16
5.1	Asthma-related questions for measuring the usefulness of the kHealthDash interface	34
6.1	Correlation measure between patient symptoms and outdoor environmental observations (April 27 - June 3, 2017)	40

Acknowledgement

I would like to acknowledge the support from everybody who helped me throughout my journey. Firstly, I would like to sincerely thank and express my gratitude to my advisor Prof. Amit Sheth for his constant guidance in the journey. He provisioned a platform to collaborate and learn innovative things at Kno.e.sis Research Center - Ohio Center of Excellence in Knowledge-enabled Computing. His patience and valuable feedback helped during the course of my research and at the time of writing this thesis.

I would like to thank rest of my committee members: Prof. Krishnaprasad Thirunarayan, Prof. Valerie Shalin and Dr. Maninder Kalra for their valuable inputs and thoroughness. I would like to thank my mentor Dr. Pramod Anantharam who is responsible for kick-starting my career at Kno.e.sis Center. My sincere thanks to my tough and fierce collaborators Revathy Venkataramanan and Dipesh Kadariya. I would also like to thank rest of the kHealth team for their help in deploying the khealth kits and discussions. My grateful thanks to my supervisors at Northwell Health: Dr. Vipul Kashyap and Dr. Robert Pratt for the discussions on my thesis. I am deeply indebted to Sarasi Sarangi, Sujana Perera, Revathy Krishnamurthy, Pavan Kapanipathi, Siva Kumar, RoopTeja Muppalla, Alan Smith, Jeremy Brunn, Lakshika Balasuriya Wijeratne, Sanjaya Wijeratne, Shreyansh Bhatt, Adarsh Alex, Ankita Saxena, Swati Padhee and Venkatesh Edupaganti for sharing their time and opinions which provided direction towards progress in my career.

Finally, I would like to thank funding source–National Institutes of Health under the Grant Number: **1 R01 HD087132-01** for the support. The content of this thesis is solely the responsibility of the author and does not necessarily represent the official views of the National Institutes of Health.

Dedicated to
my father Sridharan and mother Usha

And in glory and blessed memory of
my cousin Meera Karthik

Introduction

Internet of things (IoT) is gaining momentum and it has extensive applications in different sectors and industries [7]. Healthcare is one of the sectors that could benefit both patients, caregivers and physicians by tracking real-time patient relevant data. IoT-based health monitoring devices and sensors are widely used in various healthcare applications [4, 15], such as those involving identifying anomalies in heart functioning [23], fall detection [13], and monitoring sleep. Smartphone devices and wireless sensors captures valuable data which were previously unavailable to traditional healthcare, allowing doctors to use unprecedented amount of data to improve disease diagnosis and management.

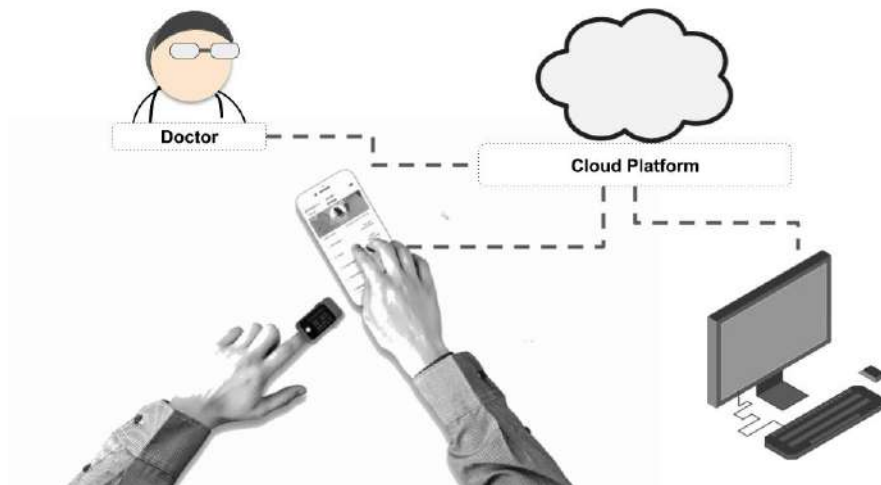

Figure 1.1: Health monitoring devices and sensors in healthcare paradigm
<https://bit.ly/2GSd18a>

Asthma is a high-burden chronic inflammatory disease with prevalence in children

and adolescent population with twice the rate compared to adults [19]. Being one of the poorly controlled diseases in the U.S. and a major cause of hospitalizations [17], asthma control and management is challenging. Asthma symptoms are triggered by environmental changes and pollutants [32] which are difficult to identify with periodic clinical visits, as each patient react differently to these triggers. For example, some patients might be sensitive to poor air quality and others might be sensitive to pollen. Highly varying environmental conditions, patient symptoms, medication usage and other patient-relevant data can be monitored continuously to understand personalized triggers that are immensely valuable to clinicians and caregivers. The data can be captured using multiple sensors which can then be integrated to reveal the underlying causes of asthma symptoms.

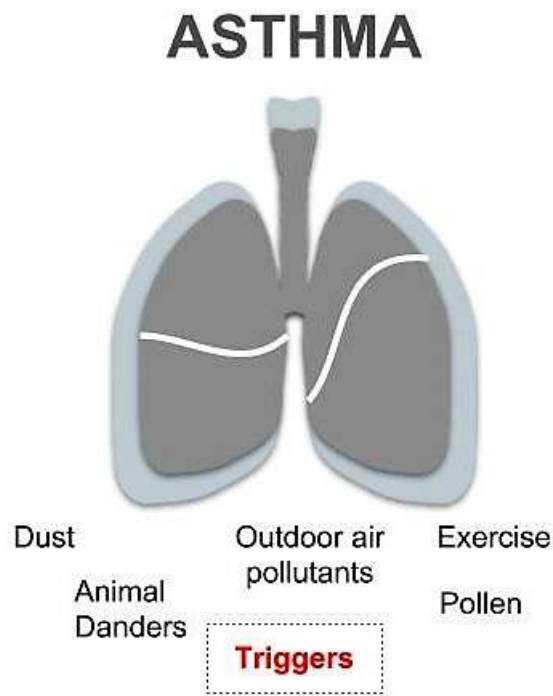

Figure 1.2: Asthma symptoms caused by triggers
<https://bit.ly/2KV7Mao>

Knowledge-enabled Health (kHealth) [30, 1] for Asthma is a multisensory approach

for better asthma management in children. kHealth-Asthma kit includes Patient Generated Health Data (PGHD) such as (1) symptoms, medication usage and activity limitation captured through contextual questionnaire using a smartphone application; (2) activity, and sleep tracking device (Fitbit) and; (3) an indoor air quality sensor (Foobot) monitoring pollutants indoors. In collaboration with Dayton Childrens Hospital (DCH), kHealth-Asthma kit is deployed to consented asthma patients in the age group of 5-17 as approved by Institute Review Board (IRB). As part of the anticipated cohort of 150 patients with completed evaluations, we have completed 73 patient evaluations at the time of this writing. Each evaluation lasts for one month. The kHealth kit used in this study has generated nearly 2.5 million data points for 50 completed patient evaluation (each one-month period) and still collecting with ongoing trials. On the whole about 1852 data points per patient per day are collected using the kHealth kit.

1.1 Challenges

- The kHealth kit collects 29 parameters per patient (example, symptoms, medication usage, activity, sleep stages, etc.) on regular basis due to the multifactorial nature of asthma [11]. These diverse set of parameters captured by sensors which are included in the kit have to be combined and analyzed for studying the causes impacting asthma symptoms.
- Indoor and outdoor environmental sensor data streams occur at much higher rate compared patient recorded readings using the kHealth kit and is difficult to analyze with human efforts.

To address the challenges mentioned above, a cloud-based asthma management platform kHealthDash was developed to perform personalized integration of data from the kHealth kit and outdoor environmental data from web services. It converts the massive

amount of data generated by the kHealth kit into meaningful information, useful for doctors to determine the causes of asthma symptoms, to help in disease management through strategies devised by Augmented Personalized Health (APH) [31]. The stages in health management strategies are (i) self-monitoring, (ii) self-appraisal, (iii) self-management, (iv) intervention, and (v) disease progression tracking and prediction. kHealthDash is a preliminary step in reaching toward visionary strategies of APH transforming the traditional healthcare.

1.2 Contribution

While previous approaches also integrate data from sensors, the primary focus was towards providing alerts about unhealthy environmental conditions and feedback about asthma control levels for patients [9, 16, 2]. In this work, in addition to integrating and visualizing multimodal data—PGHD from kHealth smartphone application, activity and sleep levels, indoor air quality, and outdoor environmental data, the personalized causes that precede the symptoms are also identified using the current system. The system assists in identifying anecdotal evidence from integrated data, and derive personalized causal associations between multimodal "trigger" data and asthma-related symptoms with validation from a clinical collaborator.

Figure 1.3 shows the architecture of kHealthDash platform which collects PGHD from kHealth kit, indoor air quality, outdoor environmental observations and enables exploration through visualization to assist clinicians to explore causal relationships. This work comprises of three major components, i.e., multimodal data sources (Chapter 4.1); cloud infrastructure (Chapter 4.2) that is robust and secure to aggregate different data streams; and cloud-based intuitive web interface kHealthDash (Chapter 4.3) that allows clinicians to monitor patients and explore for evidence to asthma outcomes.

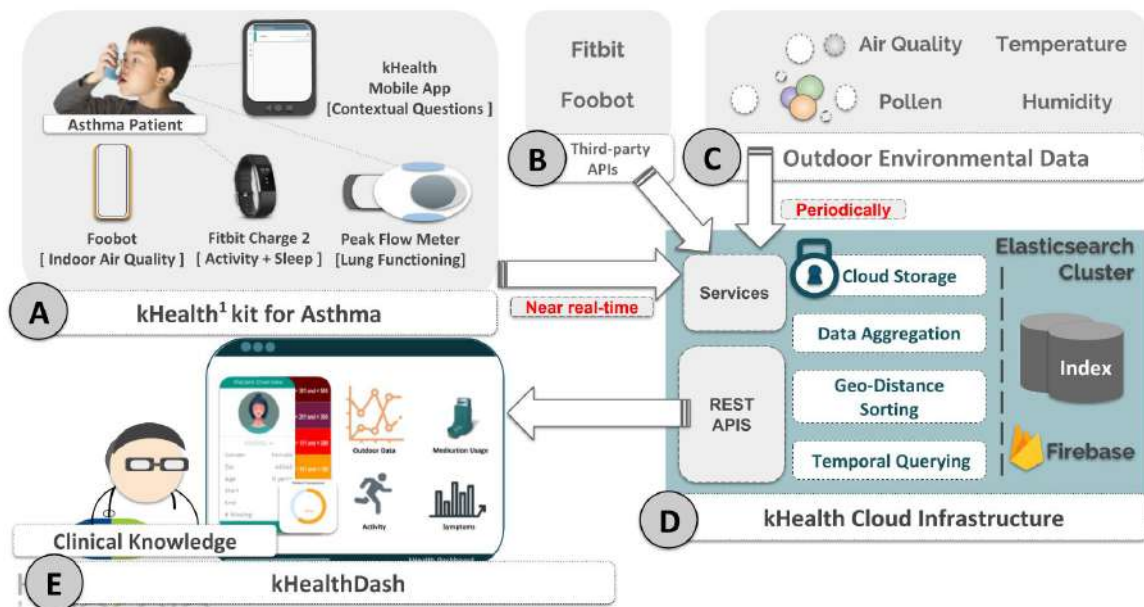

Figure 1.3: (Component-A) kHealth-Asthma kit provided to asthma participants to record readings; (Component-B) pooling sensor data from authentication-enabled third-party APIs; (Component-C) Outdoor environmental observations retrieved based on monitoring stations; (Component-D) Scalable infrastructure web services, REST APIs, cloud storage platforms; (Component-E) kHealthDash interface provides synthesised visualization of multimodal data with clinical knowledge.

Related Work

The exponential growth of Medical IoT and wearables with health applications have resulted in the extensive adoption of these devices to monitor individuals health. Asthma is one such domain with numerous active research studies for better management and control. Table 2.1 shows prior studies overall, main objectives, sensors/parameters with no patient trials or evaluation performed.

Table 2.1: Represents prior studies, main objectives, sensors/parameters used with no patient trial/evaluation performed.

Studies	Main Objectives	Sensor/Parameters
Ho-Kyeong Ra et al., (2016)	Sensor based monitoring, Collection and detection of wheeze sounds	Spirometer, Electronic Stethoscope, Sensordrone, Oximeter and Smartphone
Ryokai et al. (2015)	Visualization with Health coaches, 5 participants included	Biking, Hiking, Walking; Sleep duration
Chu et al. (2006)	Ubiquitous Warning System, Patient location	Outdoor Environmental data
LinkMedica., (Ret. 2018)	Serves as an electronic-diary	Medication usage, Peak Flow readings, Symptoms
Propeller Health., (Ret. 2018)	Tracks medication usage: Time, Location	Inhaler Sensor

2.1 Generic Studies

Personal Environmental Impact Report [18] estimates the environmental exposure based on sensors within smart phones geolocation and history. These are further fed to parallel cloud-based handlers followed by a machine learning method to perform activity classification such as whether the user is walking, being idle, or driving a vehicle. The study also measures the level of influence between users and the environment, based on exposure and impact, using existing selected metrics such as Smog Exposure, Fast Food Exposure,

Sensitive Site Impact and Carbon Impact scores, along with an ecosystem that allows users to share and analyze their scores on social media platforms such as Facebook. The study is focused on Global Positioning of their users and how best the system can be compatible with regards to users even if the location is disabled.

Doukas et al. [8] have developed a cloud platform to efficiently process, manage and visualize sensor data. The work delivers a preliminary demonstration of the way cloud computing is used in the IoT realm, consisting of Arduino board equipped with Wi-Fi adapter, accelerometer, and a couple of air quality sensors, textile sensors recording electrocardiography, body temperature and oxygen saturation and location, activity and ambient temperature using a motion sensor. Although a variety of modalities are used, no form of significant evaluation is performed or findings reported to support the claim.

Ryokai et al. [27] have built a data visualization tool with health coaches aimed at reducing the information-seeking time during a patient-clinician interaction with only 5 participants. It collects data from wearable technologies capturing activities such as biking, hiking or walking, sleep positions, and different stages of sleep such as rapid eye movement, light, and deep sleep duration.

Adopting to existing generic studies for a scalable platform which integrates sensor data and delivers processed results for providing actionable insights to clinical experts, an extensive and scalable infrastructure is developed in this thesis. Asthma management specific studies are reviewed in the upcoming section.

2.2 Asthma Management Specific Studies

Asthma Guide [25], aimed at home care management, is a system which provides a kit consisting of pulse oximeter (SpO₂), electronic stethoscope for heart rate, spirometer measuring peak flow reading, sensordrone for indoor air quality and smartphone device that prompts medication usage, activity related and other information. The work uses wheeze

sounds recorded by asthma patients through the smartphone device to classify wheezing as asthma symptom or not. The system sends alerts when pollen and air quality deviates from the healthy range. It also provides doctors and patients to view the summary of patients health and correlation measure between symptoms and patients indoor data, providing insights about the triggers. Similarly, the kHealth system is empirically evaluated over usability with regards to asthma management to make the claims stronger and to avoid spurious correlations, we also determine cause-effect relationships with clinical knowledge.

Propeller Health, a popular digital platform, provides personalized warnings based on medication usage and location of the individual [22]. They provide remote warning-based assistance to patients with respiratory diseases both in personal and population levels. The primary focus is on reducing medication usage and improving asthma management. They report about 79% reduction in rescue inhaler medication over the period of one year from the day of initiation. However, individuals activity, sleep duration, severity level, patient history, etc., which are valuable are not yet considered in decision making and are not processed within the context of the patient. Finkelstein et al. [10] have assembled a web-based approach to send alerts to hospitals when there is a deviation in Forced Vital Capacity assessment and symptom scores computed as the patients records into the system. LinkMedica [16] is a shared open tool for doctors and patients, which collects patients medication usage, Peak Flow Meter readings and symptoms reported, serving as an electronic diary to keep track of the patients health. Additionally, it provides feedback about current control level of asthma.

Other existing alert systems include ENVIROFI [9] and azma.com [2], aims to forecast unhealthy environmental conditions, weather and asthma-related news enabling patients and public to be informed of the disease. However, this disregards other factors that may affect the patients such as medical history, genetic factors, activity, etc. In addition, these efforts consider asthma patients in population level but do not yield personalized

asthma management. Chu et al. [6] developed a system which collects outdoor data based on patients location and displays it to healthcare workers to monitor and locate the patients before the occurrence of asthma-related attacks. Nevertheless, patient-relevant information such as the triggers, symptoms and medication usage has not been considered, thus only serving as a ubiquitous warning system.

While medical experts were consulted in gathering requirements in most of the approaches, unlike our approach direct clinical collaboration and patient trial such as one performed under an Institute Review Board (IRB) were not involved in these studies. We have gone beyond just aggregation, processing and visualization of multimodal data as time series but have analyzed, with a clinical collaborator, instances that indicate potential environmental triggers or medication inhaler usage impacting symptoms. This study discusses, real asthma patients' data represented in kHealthDash and how contextually relevant relationships can be explored, interpreted and clinically validated.

Technologies

kHealthDash uses a number of extensive state-of-the-art technologies to assist healthcare providers. A robust, and efficient cloud-based system infrastructure with a web interface is engineered for handling multiple and complex queries for facilitating the end-user experience (clinical experts). These are discussed briefly in this chapter.

3.1 Programming Language

A heterogeneous, scalable and data-intensive application like kHealthDash would require a lightweight programming platform like Node.js¹. Node.js follows a non-blocking I/O model which never rejects a client such as the current system web applications data request and is completely event-driven (example event, mouseover, key press, click, etc). kHealthDash web application, when made available to the public will allow several clients to log in and access the interface, which requires a handler capable of managing a considerable number of requests. Node.js, being single threaded, has the capacity to handle such amount of user requests in its event-loop. It also encapsulates within itself the worlds largest package management registry called Node Package Manager (NPM²) which allows developers to install a variety of useful libraries needed for the application(s) or building upon kHealthDash platform.

¹<https://nodejs.org/en/>

²<https://www.npmjs.com/>

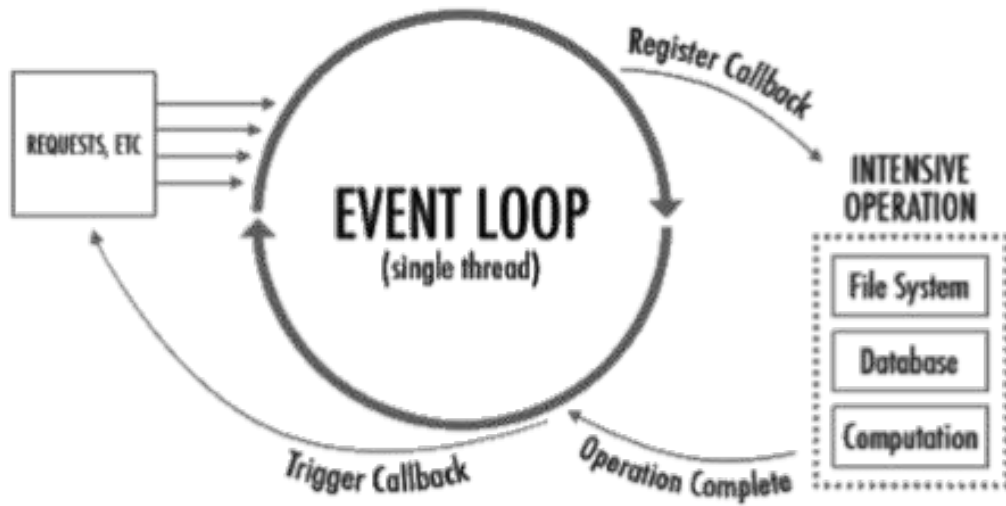

Figure 3.1: Node.js event loop work flow and handling intensive operations.
<https://bit.ly/2GxaWiR> and <https://bit.ly/2s6Tyw2>

3.1.1 Microservices

Useful services were developed in Node.js that are scheduled to be executed periodically using PM2³, a process management tool, which keeps the scripts alive forever and reloads them avoiding downtime.

3.2 Framework

In order to connect and retrieve from the database containing multi-modal data, a framework capable of interfacing with the database is required and provide processed results to the end-user interface. This work uses Express, a conservative, efficacious Model-View-Controller (MVC⁴) structured framework based on Node.js. It is capable of handling multiple interface routes, strong middle-ware to connect with databases, and a convenient mech-

³<http://pm2.keymetrics.io>

⁴https://en.wikipedia.org/wiki/Model_view_controller

anism for error handling. kHealthDash was developed using Express which handles differ-

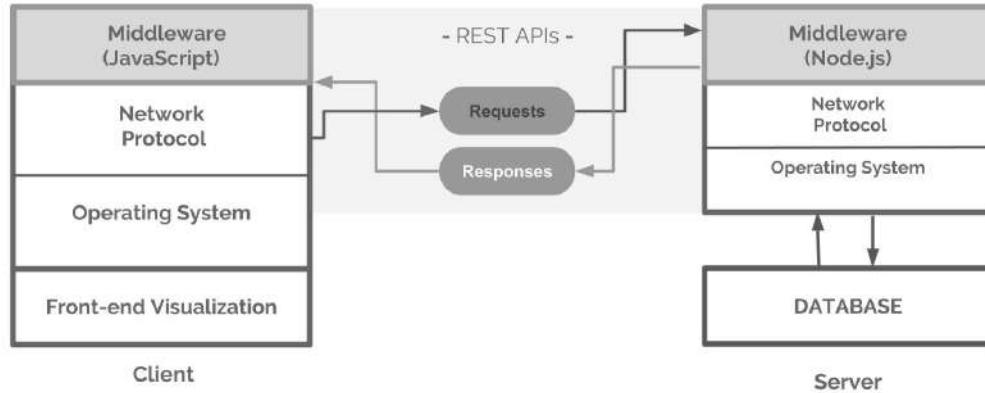

Figure 3.2: Typical Express work flow showing front-end (view), database (model) and middle-ware services, and APIs (controller)

<http://bit.ly/2I5GVb5>

ent RESTful⁵ Web Application Programming Interfaces (APIs⁶). The RESTful APIs are designed to perform complex queries to Elasticsearch⁷ database which has collected various sensor data and PGHD from kHealth kit. These responses are processed and formatted into JavaScript Object Notation (JSON⁸) message that satisfies visualization requirements.

3.3 Back-end Database

Elasticsearch, a scalable search engine and data-store based on Apache Lucene⁹ which stores and assigns identifiers to every JavaScript Object Notation (JSON) document within itself. Thereby making it easier for flexible aggregations (sum, max, min, etc.), geo-distance computations and temporal filtering. Elasticsearch storage has a flexible schema

⁵https://en.wikipedia.org/wiki/Representational_state_transfer

⁶https://en.wikipedia.org/wiki/Application_programming_interface

⁷<https://www.elastic.co>

⁸<https://www.json.org>

⁹<https://lucene.apache.org>

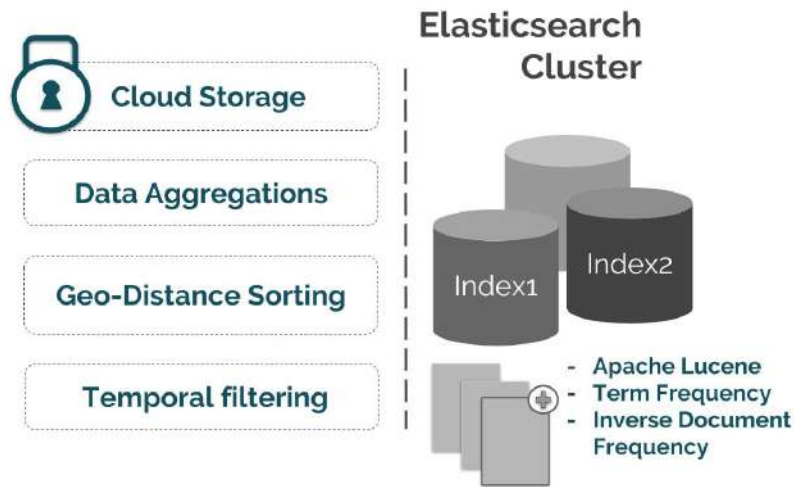

Figure 3.3: Elasticsearch indices (similar to MySQL tables), documents (records or rows), offering storage, aggregations, and filtering.

for indexing numeric-, datetime-, and geopoint-types. The strength of Elasticsearch is harnessed by efficiently storing and performing aggregations of data from all the sources discussed in this thesis.

3.4 Front-end Visualization

In this thesis, apart from the back-end framework and database selected to store and handle intermediate operations, there is a need for an user interface capable of representing different multimodal data intuitive for clinicians, such that correlations between environmental factors and asthma outcomes could be explored and identified. kHealthDash front-end visualization was developed using Hyper Text Markup Language (HTML¹⁰), Cascading Style Sheets (CSS¹¹), and JavaScript (JS¹²) with supportive libraries such as Twitters Bootstrap¹³,

¹⁰<https://en.wikipedia.org/wiki/HTML>

¹¹https://en.wikipedia.org/wiki/Cascading_Style_Sheets

¹²<https://en.wikipedia.org/wiki/JavaScript>

¹³<http://getbootstrap.com>

jQuery¹⁴, HighStocks¹⁵, and MomentJS¹⁶.

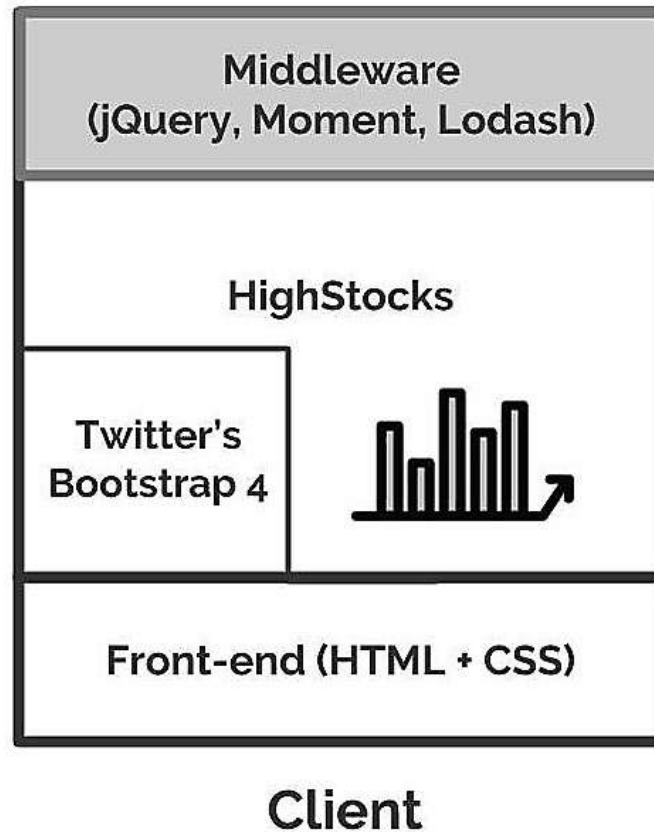

Figure 3.4: Shows the front-end interface with supporting technologies

3.4.1 jQuery

To maneuver the Document Object Model (DOM) of the front-end we use a simplistic, and powerful library, jQuery and its conventions for selecting the DOM. jQuery allows to subscribe and handle DOM events (example, hover, click, etc.), animations, and many other dynamic components within a web page.

¹⁴<https://jquery.com>

¹⁵<https://www.highcharts.com/products/highstock>

¹⁶<https://momentjs.com>

3.4.2 CSS Framework

Apart from the custom styling features we added to personalize our web pages we used Twitters Bootstrap Cascading Style Sheets framework components to add to the aesthetics, responsiveness, and user-friendliness of the interface. Badges, dropdowns, buttons, cards, navigation bar, labels, checkboxes, etc. are some of the components featured by Bootstrap and are leveraged by kHealthDash visualization platform.

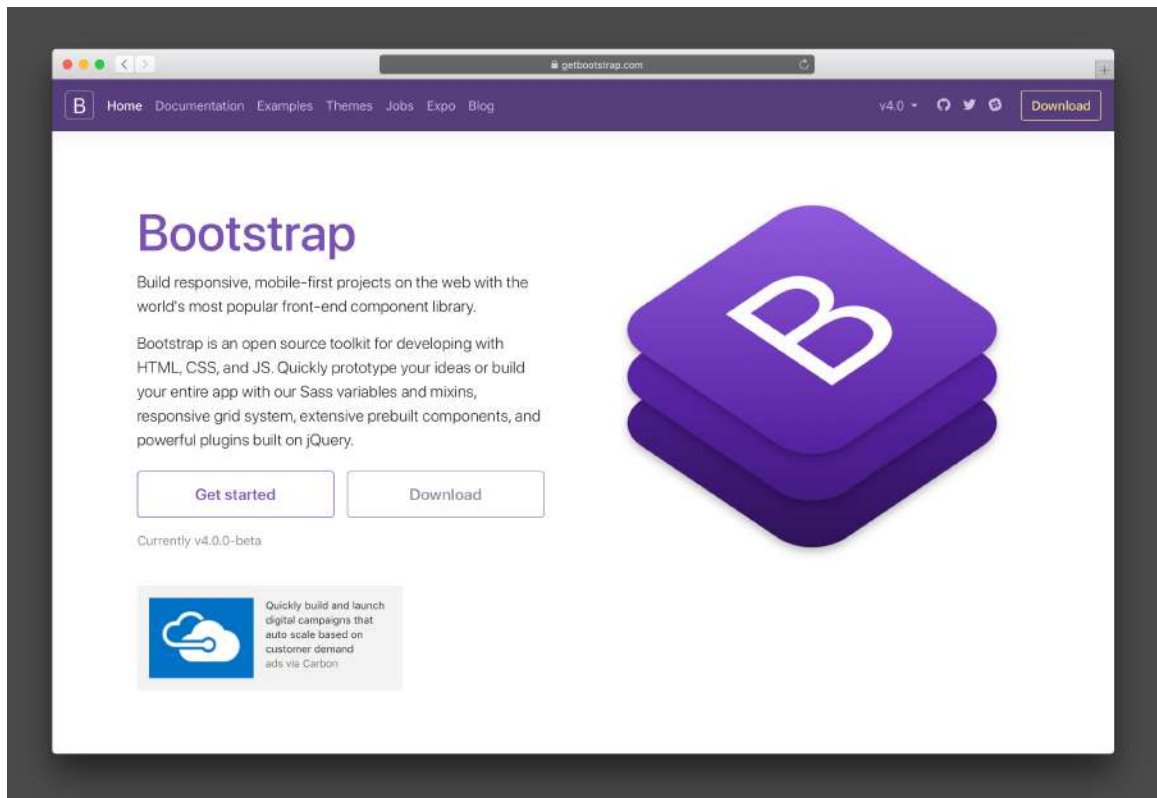

Figure 3.5: Shows Twitter’s Bootstrap CSS Framework
<http://getbootstrap.com>

3.4.3 Chart Libraries

Chart library such as Highstocks, a product of Highcharts, that provides a platform to feed an enormous number of configurations necessary for fitting visualizations. We mainly use Highstocks to leverage the time-frame navigator which allows temporal exploration of the

patient data. kHealthDash web interface uses Highstocks extensively to better visualize data from different sources that are easily understood by the user (clinicians) and with less cluttering. To provide visualizations such as patient compliance, comparative trends, etc. in the form of quickly accessible panels, we harness visualizations from a small but simplistic library called Chart.js¹⁷.

3.4.4 Date-time Serialization, and Management

IoT-based devices record time-stamp in varying formats, which causes databases, programming interfaces and middle-ware code snippets hard to interpret. The most common format is the ISO string or the Epoch Unix¹⁸ represents the entire date, and time. A valuable date-time serializing library MomentJS that parses and validates any incoming format, allows to apply formatting operations (ISO, Locale, Unix, etc.), time zone detection, and also enables time manipulation such as adding or subtracting days, hours, months, etc., that would benefit while filtering the data. This dependency is beneficial to a system like kHealthDash, where time-series exploration, and analysis are performed.

3.4.5 Utility Library

Performing functional and data intensive operations to satisfy the requirements of charts with regards to data formats was challenging. A modular utility JavaScript library Lodash¹⁹ allowed to perform a variety of data manipulative operations.

Table 3.1: Shows the utility functions provided by Lodash

Function	Description
Map	Collection of data points are iterated and processed individually
Reduce	Processed data points can be merged and transformed to produce results
Partition	Input collection can be partitioned into sub-collections based on custom condition. Example even and odd numbers

¹⁷<http://www.chartjs.org>

¹⁸https://en.wikipedia.org/wiki/Unix_time

¹⁹<https://lodash.com>

We use functions like MapReduce, and partition in our web services for processing the data points from different sources. We host an instance of Elasticsearch cluster, web services, express middle-ware (RESTful APIs, and routing), and kHealthDash web interface on an OpenStack²⁰ cloud platform secured by firewall security rules. These technologies and their use are discussed in chapter 4 and also briefed on how efficacious these were in this thesis effort.

²⁰<https://www.openstack.org>

Approach

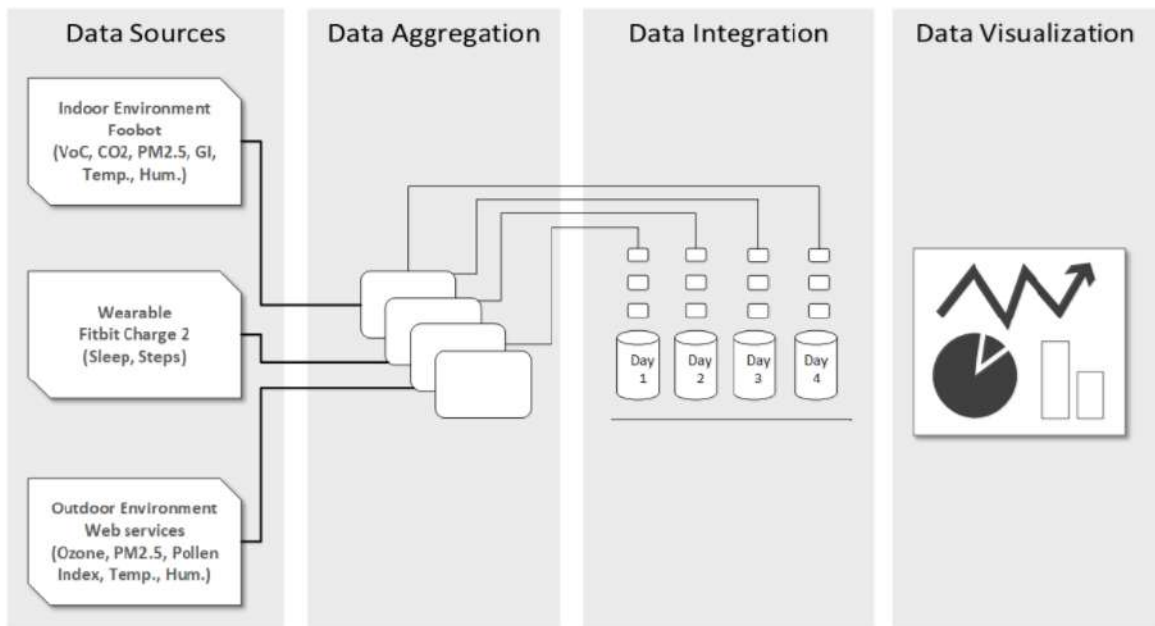

Figure 4.1: System methods showing data sources, aggregation, integration and visualization

The implementation of this work was based on how (i) aggregation, (ii) secure, processing and computation of fundamental statistical operations, and (iii) performing extensive data visualization rendering of multimodal sensor data and patient record readings. These are done to deliver a usable system which could potentially be the foundation for clinical experts for exploring factors affecting asthma outcomes.

4.1 Data Sources and Collection

kHealth-Asthma ¹ is a knowledge-enabled semantic platform which uses smart mobile application with low-cost sensors for continuous monitoring of asthma patients. kHealth-Asthma kit consists of a mobile application with contextual questions to capture prevalence of symptoms, activity limitations, and medication usage. IoT-based sensors such as Fitbit² Charge 2™, Foobot³ indoor air quality monitoring sensor and Microlife® digital peak flow meter⁴ [28] captures required parameters that are beneficial for assessing asthma symptoms and are included in the kHealth kit. The method to obtain data from these devices is discussed in the next sections.

4.1.1 kHealth-Asthma Android Application

kHealth-Asthma Android application has been designed to record responses to contextually relevant questions from patients involved in our study. These questions are improved iteratively with feedback from clinical experts, nurse coordinators, patients and researchers and reviewed by IRB. Patients are provided with a Samsung Tablet device with kHealth-Asthma Android application setup by the nurse coordinator. We set up the application for near real-time data push to the cloud storage. We developed the Android application to allow patients who experience Wi-Fi connectivity issues or low internet bandwidth (at home) to save responses locally. Later, locally stored responses are uploaded to the cloud storage when the connectivity is live. Some of the major components of the Android application are:

Questionnaire

We perform personalized analysis by devising contextual questions shown in Table. These questions are prompted twice daily as recommended by the clinical collaborator and cap-

¹<http://wiki.knoesis.org/index.php/Asthma>

²<https://www.fitbit.com>

³<http://foobot.io>

⁴<https://www.microlife.com/consumer-products/respiratory-care/asthma-monitor/pf-100>

kHealth kit: kHealth-Asthma Android App

Patient Questionnaire

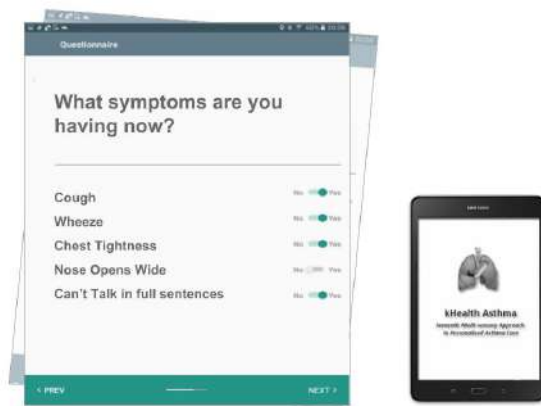

Symptoms and its types

Long acting medication usage

Short-acting medication usage

16 parameters per day per patient

Figure 4.2: The kHealth-Asthma Android App and the readings recorded by patients on a daily basis

ture patient outcomes, medication usage, and activity limitation of asthmatic children in the 5 - 17 age group. In this thesis, symptom relevant responses provided by patients are used to explore triggers which impact them.

Patient Profile Management

Clinicians prefer less effort and time in pre-deployment phase, setting up a patient profiles would be a tedious if mishandled in application level. For this reason, the application has a component for patient management which are beneficial for the nurse coordinator or the clinician to manage created patients, their compliance, and summarized trends.

Email Notifications

Several patients do not take the readings regularly and eventually have less compliance. As a result, the application is equipped with a background service which asynchronously verifies the patient answered questionnaire and triggers an email message to the clinician or the nurse coordinator if not answered for the given day. After incorporating this feature,

we noticed a substantial increase in patient compliance which is expected to be valuable for collecting continuous data points.

Over the period of one year, patient compliance towards logging readings using the kit gradually increased with improved user interface design and features. Currently, the application is re-engineered based on an advanced user interface principle Material Design⁵ which has proved to be efficient in delivering smooth and elegant user interface and relevant components.

4.1.2 Wearable Sensor: Activity and Sleep



Figure 4.3: Fitbit Charge 2™ that tracks activity (steps, active minutes), sleep and heart rate.

<https://www.fitbit.com/charge2>

Existing published validated studies has proved Fitbit to be appropriate for monitoring patient well-being. Fitbit Charge 2™ is included, cost-efficient wearable with essential in-built sensorstri-axis accelerometer, optical LED monitor, altimeter and vibration motor. The device tracks activity (steps taken, calories burned, distance covered in miles, active

⁵<https://material.io/guidelines>

minutes, lightly active minutes, and sedentary minutes), and duration in different stages of sleep along with sleep awakenings (minutes in REM, light, deep and asleep). Its ability to monitor individuals comprehensively allows researchers to derive valuable insights from individuals physical data. Activity limitation, disturbed sleep, and outdoor activity are essential information for analyzing asthmatic outcomes of patients hence it is included in the kHealth kit.

Every device provided is associated with an account for it to continuously synchronize patient recorded activity and sleep data to the tablet device and forwarded to Fitbits cloud which is later retrieved to cloud infrastructure built in this work. This requires authentication-enabled APIs and data retrieval and handling discussed in the upcoming chapter.

4.1.3 Indoor Environmental Data

Foobot is an indoor monitoring WiFi-enabled device with inbuilt sensors metal oxide semiconductor, optical and temperature sensors combined with computing techniques to track indoor air quality pollutants. The device indicates good or poor air quality information, using LED light patterns. Foobot measures essential parameters such as carbon dioxide (ppb), volatile components (ppm), particulate matter (μ/m^3), global index (constructed unit), indoor temperature ($^{\circ}F$) and indoor humidity (%) in real-time and stores it in cloud. The device turns blue when air quality is good and orange when air quality is poor, other patterns⁶ are assigned for notifications, starting up/shutting down the device, and connectivity with vendors android application. Foobot offers cloud-to-cloud integration which allows it to activate purifiers and other similar systems whenever the air pollution gets high for example, NEST thermostat.

Monitoring the patient indoor environment could be highly beneficial to understand the factors triggering patients asthma symptoms. As a result, we included Foobot as part of

⁶<https://bit.ly/2kq1ZhD>

kHealth kit: Indoor Air Quality Sensor

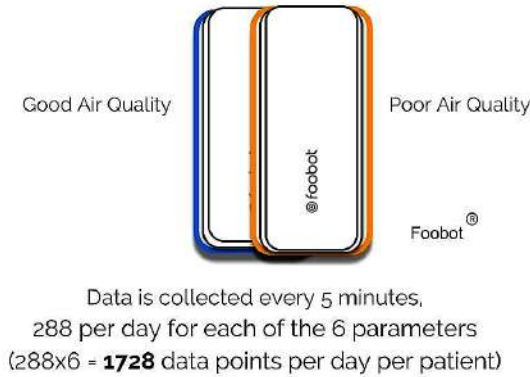

Parameters*

Volatile Compounds	(ppb)
Indoor Temperature	(°F)
Indoor Humidity	(%)
Particulate Matter 2.5	($\mu\text{g}/\text{m}^3$)
Carbon Dioxide	(ppm)
Global Pollution Index	(const. unit)

Figure 4.4: Foobot - Air quality monitoring sensor placed on a table indoors, showing the two important LED patterns when air quality is good or poor.

<http://foobot.io>

kHealth kit for asthma, provided to each of the patients and recommended to be placed in a most common place at home. Foobot is associated with an account for it to continuously synchronize patients home air quality data to table device and forwarded to the Foobots cloud and later to cloud infrastructure built in this work. Detailed approach on sensor data retrieval from authentication-enabled third-party APIs and Web services are discussed in section 4.2.

4.1.4 Outdoor Environmental Observations

Outdoor environmental observations are valuable since patients exposed to unhealthy environment, experience asthmatic outcomes. Varying factors such as air quality, pollen, and weather conditions, if collected are convenient for healthcare providers for exploring the deviations, to corroborate their impact on patients asthma outcomes. Outdoor conditions are reported by physically installed samplers [14] that are installed and monitored by several station towers which are spread across the state. We collected environment ob-

Web Services for Outdoor Environment

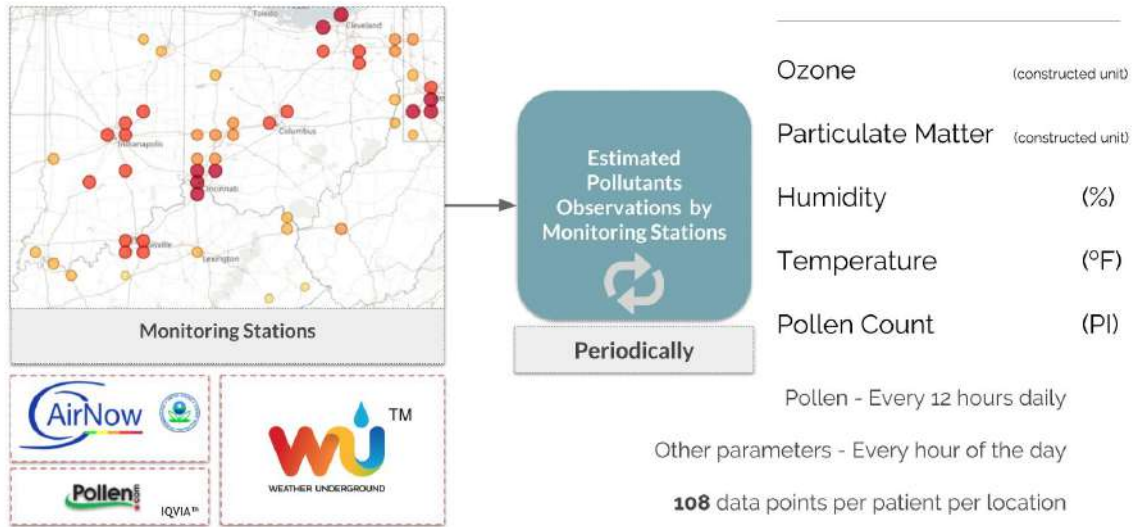

Figure 4.5: Data collected from outdoor monitoring stations for each observation for every hour of the day.

servations such as ozone (air quality index), particulate matter (air quality index), pollen count (pollen allergy index), temperature (degree Fahrenheit), and humidity (percentage) periodically for every hour of the day from EPA’s AirNow⁷, Pollen.com⁸, and WeatherUnderground⁹ for Ohio, United States of America.

4.1.5 Digital Peak Flow Meter

Digital peak flow meter PF100 by Microlife is a device for adults and pediatric patients for monitoring their lung capacity that are indicators for asthma outcomes. This device measures Peak Expiratory Flow (PEF) and Forced Expiratory Volume per second (FEV1). As recommended by our clinical collaborator we include Peak Flow Meter in the kHealth kit and allow patients to record and report the readings to the Tablet device. Currently we are attempting to integrate the device with kHealth-Asthma android app for automatically capturing the measurement. 2214 data points were collected from Peak Flow Meter for 40

⁷<https://airnow.gov>

⁸<https://pollen.com>

⁹<https://wunderground.com>

kHealth kit: Digital Peak Flow Meter



Parameters*

Peak Expiratory Flow	(PEF)
Forced Expiratory Volume in one sec	(FEV)

Period - Twice daily (4 data points per day per patient)

Figure 4.6: Digital Peak Flow Meter which measures peak expiratory flow, and forced expiratory volume per sec.

patients each of one-month trial period.

4.2 Data Aggregation

Our scalable cloud infrastructure, shown in Figure 1.3D queries and aggregates (i) multi-modal data from kHealth kit readings, (ii) sensor data from the third-party cloud (Figure 1.3B), and (iii) outdoor environmental observations (Figure 1.3C) into Elasticsearch (ES) cloud storage which provides fast and efficient indexing mechanism for easy querying.

4.2.1 Patient recorded readings

Patient recorded readings such as responses to the questionnaire, peak flow meter, and Fitbit observations are monitored on a continuous basis requires real-time database technology. This is accomplished by using Googles Firebase¹⁰, a cloud-based, real-time, data

¹⁰<https://firebase.google.com>

storage service which allows secure, and persistent (cache storage) real-time data push from android-device clients used by patients. Although Firebase provides a level of data security¹¹, de-identified patient-relevant data in a third party cloud storage is subject to privacy-risks [29]. For this reason, data collected on Firebase is transferred to Kno.e.sis¹² private cloud instance.

4.2.2 Mapping Inventory and third-party APIs

```
object {1}
  array {1}
    sensor_intermediate {3}
      aliases {0}
        (empty object)
      mappings {1}
        link {1}
          properties {4}
            fitbit_id {2}
              type : text
              fields {1}
                keyword {2}
                  type : keyword
                  ignore_above : 256
            foobot_id {2}
              type : text
              fields {1}
                keyword {2}
                  type : keyword
                  ignore_above : 256
            kit_number {1}
              type : long
              timestamp {1}
                type : date
```

Figure 4.7: Mapping inventory schema from Elasticsearch cloud storage

A pre-deployment step is performed wherein a kHealth asthma kit is labelled and synced with third-party clouds such as Fitbit and Foobot. In specific, we maintain a kit mapping inventory with a schema (shown in Figure 4.7) referring to smart tablet device, activity-tracker, and indoor air quality sensor respectively which is later used to retrieve data from individual third-party APIs (as shown in Figure 1.3B). Relevant data from third-party APIs are retrieved using mapping inventory identifiers using Open Authentication

¹¹<https://firebase.google.com/docs/auth/web/password-auth>

¹²<http://knoesis.org>

(OAuth2.0¹³) workflow shown in Figure 4.8. OAuth2.0 workflow requires third-party (example, Fitbit) to request users (Fitbit tracker assigned with fitbit_id) on behalf of consumers (Kno.e.sis Research Center - Wright State University) for a consent to access corresponding device_id's Fitbit data. After successful consent, third-party vendor provides a temporary access token and a one-time usable refresh token, a separate timer based token inventory is maintained to refresh access tokens once they expire. This allows our inventory to preserve active anytime useable tokens for accessing third-party APIs for streaming data access.

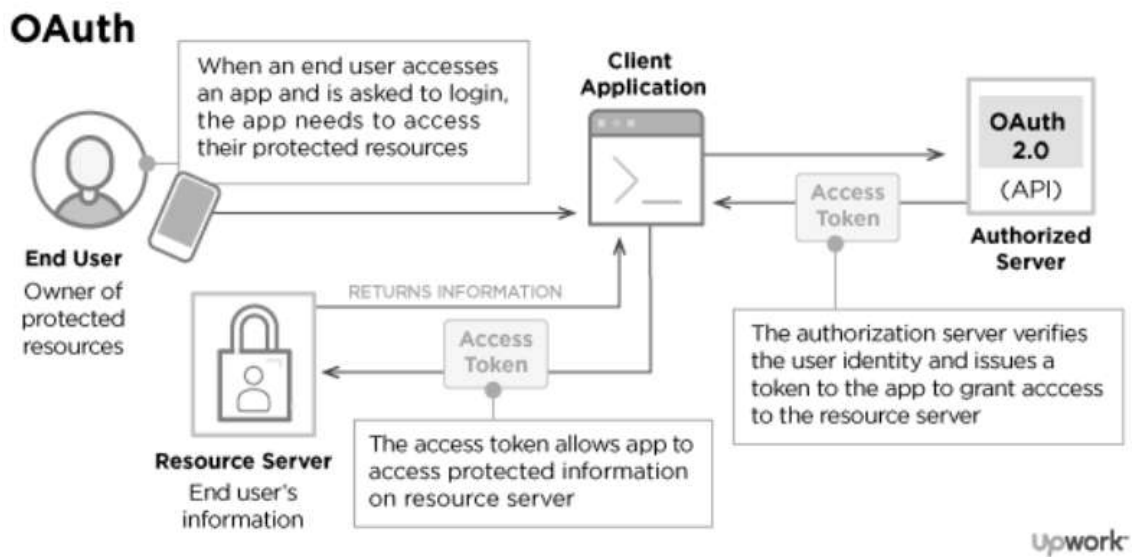

Figure 4.8: Represents the Open Authentication-enabled workflow between a user and resource servers such as Fitbit or Foobot.

<http://bit.ly/2Fimp9l>

Individual patient's sensor readings such as indoor air quality data, activity, sleep and heart rate data are then retrieved using RESTful Web Application Programming Interfaces provided by Fitbit and Foobot cloud services respectively and are constantly fed to Elastic-search storage for analysing.

4.2.3 Outdoor Environmental Web-services

¹³<https://oauth.net>

Services present collects environmental observations based on individual monitoring stations geographical location provided by respective sources and inserts the environmental observations (example, Ozone 55, Sinclair Dayton) with geographical location and timestamp into the cloud storage (Elasticsearch) as shown in Figure 1.3C. This procedure allows our consumers to query for any patients region, which is Geo-coded to approximate Geo-coordinates and then query Elasticsearch to perform Geo-distance sorting (minimum) with temporal filtering. This fetches accurate environmental value observed by monitoring stations. If no value is present, the next nearest value reported by a monitoring station is obtained.

4.3 Data Modelling and Processing

We developed REpresentational State Transfer (REST) services to achieve critical processing tasks. Major steps involved in querying patient-reported data from kHealth kit and asthma triggers, how these are merged to fit the visualization are discussed here.

4.3.1 Outdoor environmental data and Geo-spatial Modelling

Given the aggregated environmental data associated with Geo-locations of the monitoring stations, following steps are performed:

- Given that patients zip code, we find approximate Geo-coordinates by third-party tools¹⁴ (Geo-coding)
- Geo-distance querying which fundamentally uses Haversine¹⁵ method is performed, which considers two points in a spherical surface such as the earth [26]. This is followed by finding the nearest located monitoring station (point) with the environ-

¹⁴<https://www.mapbox.com/geocoding>

¹⁵https://en.wikipedia.org/wiki/Haversine_formula

mental observation. Monitoring station within the shortest distance d has observed outdoor value, the task is to find d from the equation below:

$$H(d/r) = H(\theta_2 - 1) + \cos(\theta_1)\cos(\theta_2)H(\lambda_2 - \lambda_1)$$

H	Haversine function
r	Radius of the sphere
d	The distance between two points
θ	Latitudes of the two points
λ	Longitudes of the two points

In any case, if there are no values observed by monitoring station (due to accidental events, technical difficulties, etc..) succeeding nearest station with outdoor value is utilized for visualization and analysis.

4.3.2 Indoor Environmental data and Wearable data

Our web services pool indoor air quality sensor data from Foobot, and activity and sleep data from Fitbit servers using the OAuth-enabled REST APIs provided and are fed to Elasticsearch cloud storage (shown in Figure 1.3B). Visualization interface query Elasticsearch through web-services designed to retrieve indoor environmental observations based on device identifier associated with the respective Foobot device provided as part of the kHealth kit, mechanism is discussed in section 4.2.

4.3.3 Patient Generated Health Data (kHealth-Asthma App)

Patient recorded readings from tablet device with kHealth-Asthma app are uploaded in near real-time to the Elasticsearch cloud storage. Readings such as symptom occurrence, symptom categories and medication intake retrieved from the Elasticsearch.

Once all the observations from each type are retrieved, they are filtered based on deployment dates (period) of the patient trial and segregated into buckets based on given interval such as day, hour, 12 hours, etc., allowing end-users to explore data comprehensively. Fundamental statistical operations are performed over the items in each bucket which assist in making observations from data with different units, and modalities which might deviate to impact the patient and result in asthmatic symptoms. Several, scalable processing schemes such as mapping, reducing, etc., are performed over the data to provide satisfactory response (parsed) needed for the visualization.

4.4 Data Visualization

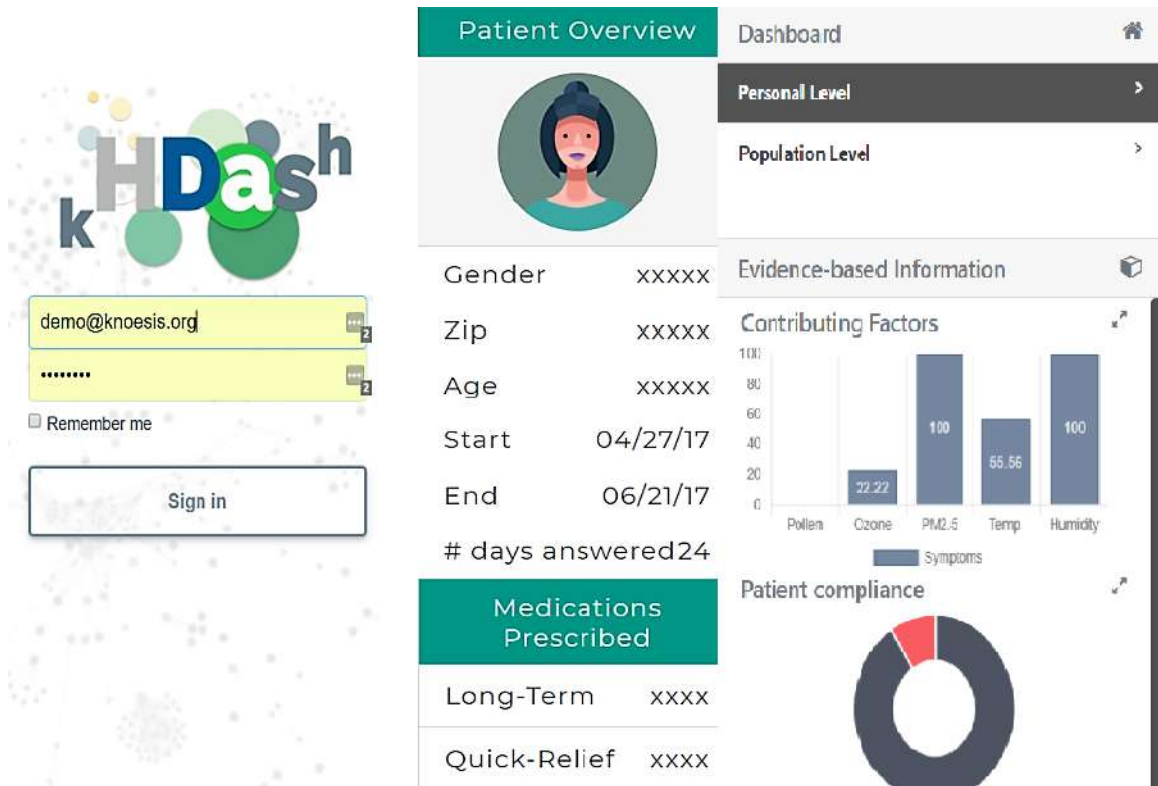

Figure 4.9: kHealthDash login screen, patient overview and quick-access summary displaying anecdotal instance outcomes, patient compliance, and discrepancy analysis

In order to deliver illustrative representations convenient for understanding and ana-

lyzing the causes of asthma symptoms, we designed a personalized cloud-based interface kHealthDash (1.3E) shown in Figures 4.9, 4.10 and 4.11, which was enhanced with collaborative clinical knowledge. Several components were developed in the user-interface such as quick-summary side panel, and multi-series plot panels. Clinicians are allowed to explore data in intervals such as every day, hour, or 12 hours, and normalize the data to 0-100 scale, flexible for exploration and analysis.

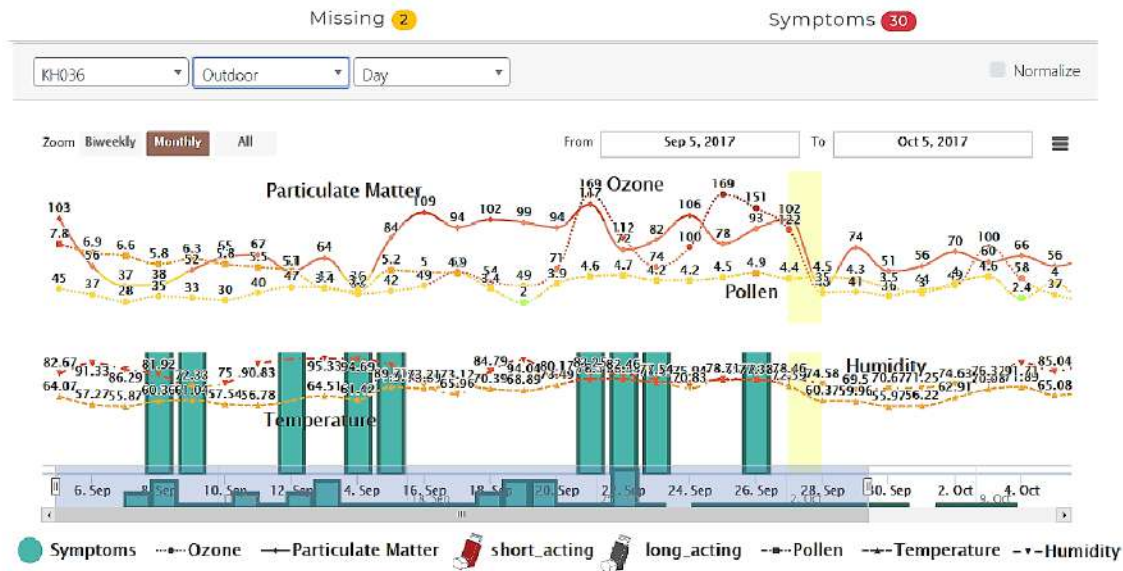

Figure 4.10: kHealthDash user-interface visualizing outdoor environmental observation versus a patient reported symptoms and medications

This panel visualizes various outdoor parameters collected by web services discussed earlier along with symptoms occurred and medications taken. After receiving feedback from our clinical collaborator, we separated the y-axis into two and distributed the outdoor parameters with symptoms. The interface consists of a combined multi-series graph plot (split axes) for PGHD, outdoor, indoor environmental data and shows a quick summary for clinicians to perform implications. The graph plots can also be time-frame adjustable aiding in slicing the entire deployment timeline into smaller chunks easier for gleaning observations.

4.4.1 Demonstration

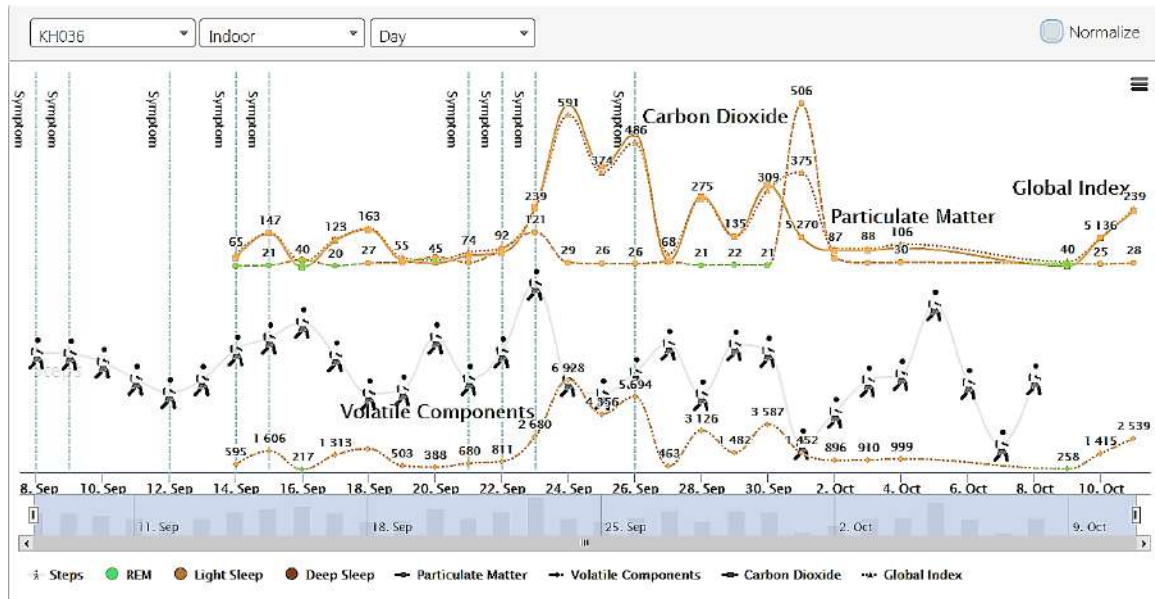

Figure 4.11: kHealthDash user-interface visualizing indoor environmental observation, activity and sleep stages versus patient recorded symptoms and medication usage.

Ensuring privacy and security, including Health Insurance Portability and Accountability Act (HIPAA) compliance [12], are critical components of any effort involving patient data. Since kHealthDash Web interface deals with health-related data, Hypertext Transfer Protocol Secure (HTTPS¹⁶) was force enabled through a third-party vendor Cert-Bot¹⁷. This process required us to use and enforce users for a Secure Socket Layer (SSL)¹⁸ certificate that ensures secure transfer of the messages especially health-related data. Online link providing documentation and demonstration of respective components in kHealthDash web interface such as landing page, historic exploration of outdoor data, patient disease progression, and discrepancy analysis are described in the link — <https://bit.ly/2Gu6FMN>.

¹⁶<https://en.wikipedia.org/wiki/HTTPS>

¹⁷<https://certbot.eff.org>

¹⁸<http://info.ssl.com/article.aspx?id=10241>

Evaluation

kHealthDash developed for clinicians was evaluated based on the usefulness and overall usability. That is, how easily clinicians were able to explore patient relevant information collected by kHealth kit and usability with respect to obtaining users opinion about kHealthDash visualization platform. The metrics selected, experiment performed, and the results obtained are discussed briefly in the upcoming sections.

5.1 Metrics

5.1.1 Usefulness

Patient information such as symptoms reported, medication usage (e.g., rescue inhaler) are combined with environmental observations to identify correlations using kHealthDash. To assess ease of use, kHealthDash is evaluated by developing asthma-related questions which are responded by participants. Table 5.1 shows asthma-related questions that are developed and reviewed by the clinical collaborator involved in this study. It contains response choices ranging from 0 to 10 scale where former is least likely and latter being most likely. Each question captures how likely the participants were able to find answers with kHealthDash interface and without the interface.

Table 5.1: Asthma-related questions for measuring the usefulness of the kHealthDash interface

Question	Choices (Likert scale)
How likely were you able to identify symptoms for Patient-A?	0 to 10
How likely were you able to find the outdoor parameters contributing for Patient-A	0 to 10
Ozone	
Particulate Matter	
Pollen	
Temperature	
Humidity	0 to 10
How likely were you able to find correlation between short-acting medication and symptoms for Patient-A	

5.1.2 Usability

Overall usability of the system was captured using System Usability Scale (SUS) criteria [5]. It is a standard measure which captures the usability with responses from participants for a set of 10 predefined questions¹. Each question has a Likert scale with 1 (strongly disagree) to 5 (strongly agree) for the users to answer. SUS score is calculated based on even numbered and odd numbered responses (agreement) provided for each question by a participant. The resulting SUS score ranges from 0 to 100 for an individual participant. Previous studies were evaluated with SUS criteria revealed that a score of 68 is the average. Any score above 68 conforms to the standard web interface criteria and considered as a good SUS score [3].

5.2 Method

Qualtrics [24], an online survey designing tool was used to create a questionnaire and receive responses through the web from participants. Domain experts (involved in pediatric pulmonology, and allergy departments) were enrolled from Dayton Childrens Hospital (DCH) with an average healthcare experience of 11 years. We also performed the experiment with non-clinical students (researchers) to evaluate the usefulness. They were non-clinical students enrolled from the Kno.e.sis Center² and were provided with a back-

¹https://en.wikipedia.org/wiki/System_usability_scale

²<http://knoesis.org>

ground description about asthma, triggers and resulting symptoms.

We focused on collecting responses from both groups because it provides contrasting results for understanding the usefulness of kHealthDash from diverse groups. Two asthma patients data (Patient-A and Patient-B) collected with a trial period of 30-day each were selected based on higher compliance in using the kHealth kit. The participants were asked to respond to questions relevant to asthma using the Patient-As data represented in a tabular format. Then, participants were asked to respond to the same set of questions using kHealthDash web interface. The same procedure was repeated for Patient-B as well. This is performed to understand how useful the kHealthDash is when compared to existing raw tabular data representation. Lastly, all participants were asked to take the SUS relevant survey which contains 10 predefined questions to assess the overall usability from a general perspective.

Since there were two patient data provided to 5 domain experts and 5 non-domain experts, we received a total of 20 responses. These responses helped in evaluating the overall usefulness of kHealthDash web interface. Below present the results obtained in the upcoming section which describes the difference and improvement in usefulness without kHealthDash and with kHealthDash. We also present the SUS Score calculated for kHealthDash obtained from 5 domain experts and 5 non-domain experts using SUS questionnaire.

5.3 Results

5.3.1 Usefulness

Patient-A and Patient-B responses obtained from each participant were averaged for tabular response and kHealthDash interface respectively. These are further averaged for all the participants, based on tabular response and kHealthDash interface which is shown in Figures [5.1](#) and [5.2](#). Values obtained from both domain and non-domain participants are an-

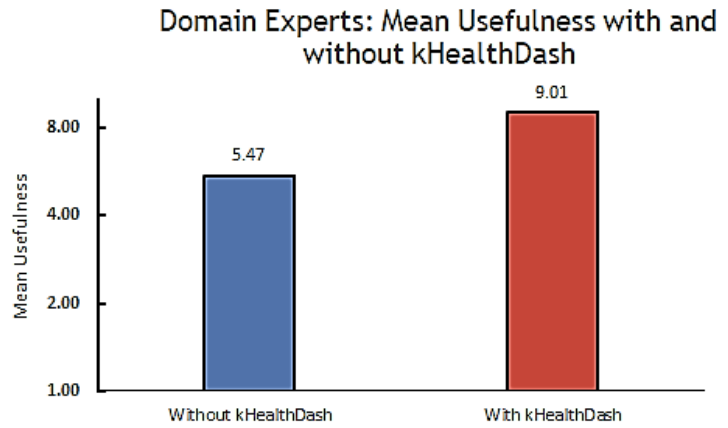

(a)

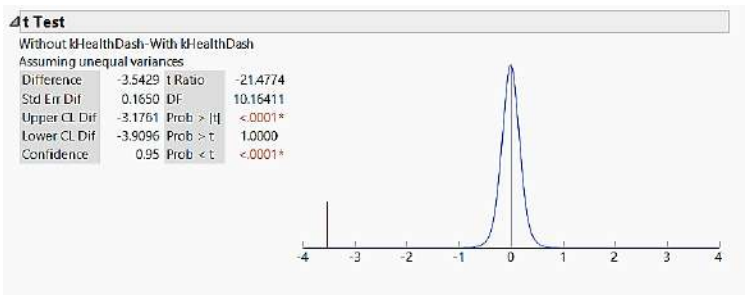

(b)

Figure 5.1: (a) Shows mean score for domain experts without kHealthDash and with kHealthDash (b) t-test with p-value for domain experts for comparing the two distributions

analyzed and plotted to present the mean usefulness with and without kHealthDash interface. We also studied with t-testing (comparing two distributions) to prove that the difference is significant. We obtained p-values 0.001 and 0.0008 (p-values < 0.05) for domain and non-domain experts respectively. Distribution for both the groups is provided in the Figures 5.1 and 5.2. Results obtained depict that the web interface is a better and useful means to explore triggers and asthmatic outcomes.

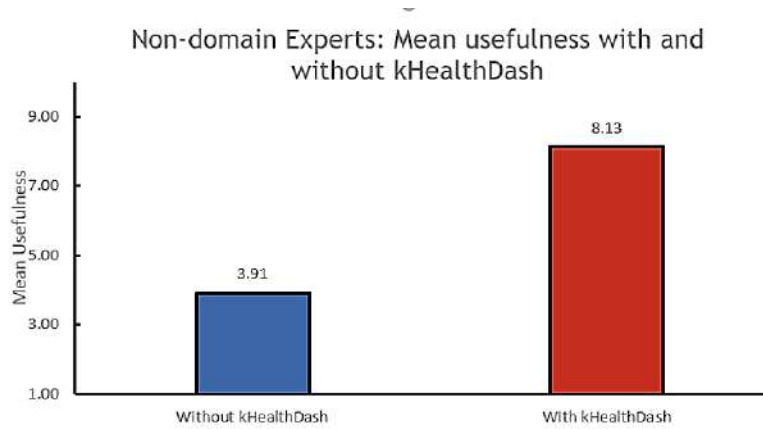

(a)

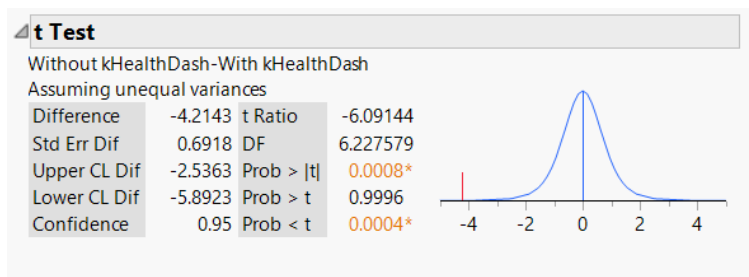

(b)

Figure 5.2: (a) Shows mean score for non-domain experts without kHealthDash and with kHealthDash (b) t-test with p-value for non-domain experts for comparing the two distributions

5.3.2 System Usability Scale

SUS questionnaire prompted to 5 domain and 5 non-domain experts resulted in 10 SUS scores to measure the overall usability. SUS scores obtained were averaged for both field participants and presented as shown in the Figure 5.3. We obtained a SUS score of 80.5 from domain experts and 75.83 from non-domain experts depicting kHealthDash as a good web interface.

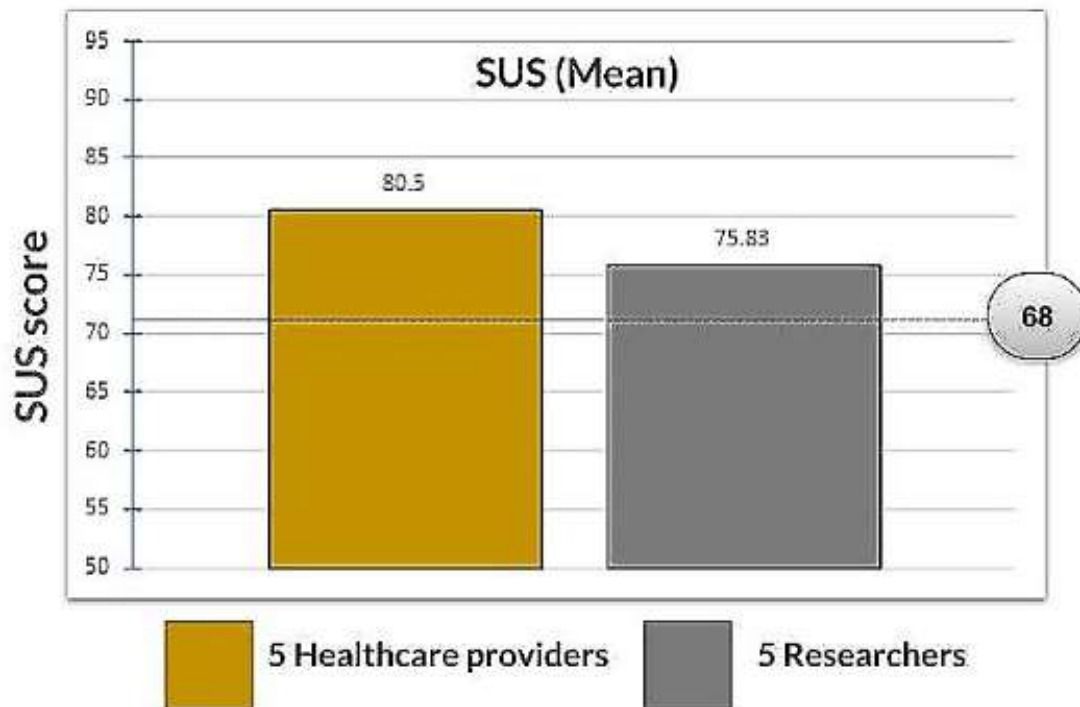

Figure 5.3: Shows mean SUS score for domain and non-domain participants

Discussion and Analysis

We studied the data from a recruited asthma patient to demonstrate the need for multimodal integration, visualization, and analysis with clinical knowledge. From the multimodal data as discussed in Chapter 4, many causal relationships could be derived. Observing variation in potential outdoor environmental data (cause) resulting in asthma-related symptoms (effect), in general, is regarded important by clinicians. To illustrate, we review one of the deployed kHealth kit from April 27, 2017 - June 3, 2017, for a 12-year old child, diagnosed with asthma, to help doctors identify triggers causing the symptoms and develop trigger avoidance strategies.

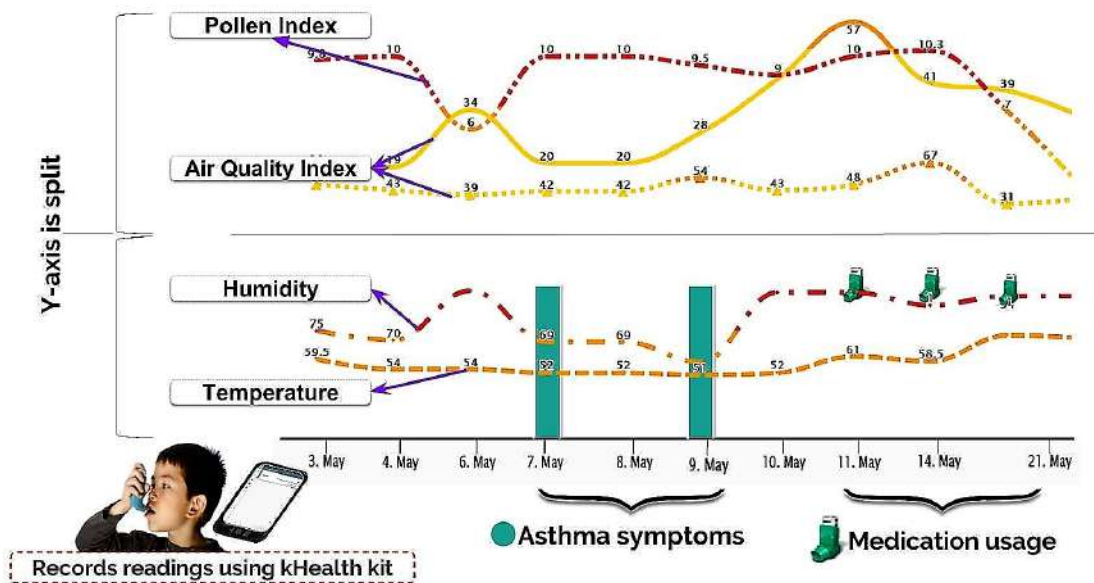

Figure 6.1: An instance of asthma patient readings on kHealthDash interface (May 3 to May 21, 2017)

Table 6.1: Correlation measure between patient symptoms and outdoor environmental observations (April 27 - June 3, 2017)

	Air Quality		Pollen	Temperature	Humidity	Medication Usage	
	Ozone	Particulate Matter				Long-term	Quick-relief
Correlation (r)	0.150702	-0.0959	0.338226	-0.2128	-0.47668	0.02538	0.106024

Table 6.1 shows Pearsons correlation (r) [21] measure which ranges between -1 to +1 and is used to assess the significance of the relationship between outdoor environmental observations and symptoms. We noticed a positive correlation (0 to +1) for pollen and negative correlation (-1 to 0) for humidity with respect to symptoms. While an instance (shown in Figure 6.1) from the deployment obtained using kHealthDash shows that increased pollen count, ozone, particulate matter, and humidity may have resulted in asthma-related symptoms on May 7 and May 9, 2017, supporting a causal connection. Considering all the evidence we analyzed for this patients readings, it is likely that ozone, particulate matter, and pollen are the primary triggers for the symptoms and verified the instances with the clinician. It can be observed that correlations alone are not strong enough to support the decision-making and it is important to observe causal relations which could also eliminate any weak and spurious correlations. Identifying applicable personalized cause-effect relationship can reinforce our decision-making process. Reporting that the symptoms are triggered by pollen count, and air quality, to a personal physician, can enable them to devise appropriate strategies for avoiding triggers.

In this thesis, we discuss the ability of a cloud infrastructure and kHealthDash web interface to consolidate and analyze PGHD from different sensors, providing an integrated method for action recommendation in the context of asthma. We evaluated kHealthDash for its usefulness and overall usability for domain (clinicians) and non-domain (researchers) participants. Our project funded by National Institutes of Health (NIH) [20] is expected to complete a total of 150 patient trials. These patients will be enrolled from Dayton Childrens Hospital for one or three month period each.

Conclusion

IoT-sensors and health monitoring systems are evolving, eventually leading to a paradigm shift in disease management. Asthma being multifactorial [11], requires exploring multimodal resources to understand the triggers that cause asthma symptoms, to enable prevention. Specifically, a broad and integrated mechanism is necessary to acquire anecdotal evidence that can eventually help manage asthma and prevent asthma attacks. In this work, a cloud-based infrastructure capable of integrating multimodal data and an intuitive web interface was developed. Further, this system allows exploring personalized triggers to corroborate with asthma-relevant information, providing a foundation for compiling anecdotal evidence, of which 80% of the anecdotes were explained and verified.

Our ongoing work involves using kHealthDash to develop heuristics based rules from the clinician verified evidence and to use them in predicting the occurrence of symptoms which would immensely benefit doctors and patients. Such a system conforms to the visionary health strategies devised by Augmented Personalized Health [31].

Bibliography

- [1] Pramod Anantharam, Tanvi Banerjee, Amit Sheth, Krishnaprasad Thirunarayan, Surendra Marupudi, Vaikunth Sridharan, and Shalini G Forbis. Knowledge-driven personalized contextual mhealth service for asthma management in children. In *Mobile Services (MS), 2015 IEEE International Conference on*, pages 284–291. IEEE, 2015.
- [2] azma.com. azma, 2017. <http://www.asthmaforecast.com>.
- [3] Aaron Bangor, Philip T Kortum, and James T Miller. An empirical evaluation of the system usability scale. *Intl. Journal of Human–Computer Interaction*, 24(6):574–594, 2008.
- [4] Chintan Bhatt, Nilanjan Dey, and Amira S Ashour. Internet of things and big data technologies for next generation healthcare. *Springer*, 2017.
- [5] John Brooke et al. Sus-a quick and dirty usability scale. *Usability evaluation in industry*, 189(194):4–7, 1996.
- [6] Hsueh-Ting Chu, Chir-Chang Huang, Zhi-Hui Lian, and Jeffrey JP Tsai. A ubiquitous warning system for asthma-inducement. In *Sensor Networks, Ubiquitous, and Trustworthy Computing, 2006. IEEE International Conference on*, volume 2, pages 186–191. IEEE, 2006.

- [7] Li Da Xu, Wu He, and Shancang Li. Internet of things in industries: A survey. *IEEE Transactions on industrial informatics*, 10(4):2233–2243, 2014.
- [8] Charalampos Doukas and Ilias Maglogiannis. Bringing iot and cloud computing towards pervasive healthcare. In *Innovative Mobile and Internet Services in Ubiquitous Computing (IMIS), 2012 Sixth International Conference on*, pages 922–926. IEEE, 2012.
- [9] ENVIROFI. The environmental observation web and its service applications within the future internet, 2017. <http://www.envirofi.eu>.
- [10] Joseph Finkelstein, MR Cabrera, and G Hripcsak. Web-based monitoring of asthma severity: a new approach to ambulatory management. In *Information Technology Applications in Biomedicine, 1998. ITAB 98. Proceedings. 1998 IEEE International Conference on*, pages 139–143. IEEE, 1998.
- [11] Center for Disease Control and Prevention. Most recent asthma data, 2016. <https://www.cdc.gov>.
- [12] Centers for Disease Control, Prevention, et al. Hipaa privacy rule and public health. guidance from cdc and the us department of health and human services. *MMWR: Morbidity and mortality weekly report*, 52(Suppl. 1):1–17, 2003.
- [13] Tuan Nguyen Gia, Igor Tcareno, Victor K Sarker, Amir M Rahmani, Tomi Westerlund, Pasi Liljeberg, and Hannu Tenhunen. Iot-based fall detection system with energy efficient sensor nodes. In *Nordic Circuits and Systems Conference (NORCAS), 2016 IEEE*, pages 1–6. IEEE, 2016.
- [14] JB Harrington, GC Gill, and BR Warr. High-efficiency pollen samplers for use in clinical allergy. *Journal of Allergy*, 30(4):357–375, 1959.

- [15] SM Riazul Islam, Daehan Kwak, MD Humaun Kabir, Mahmud Hossain, and Kyung-Sup Kwak. The internet of things for health care: a comprehensive survey. *IEEE Access*, 3:678–708, 2015.
- [16] LinkMedica. Linkmedica, 2017. <http://linkmedica.co.uk>.
- [17] Matthew Masoli, Denise Fabian, Shaun Holt, and Richard Beasley. The global burden of asthma: executive summary of the gina dissemination committee report. *Allergy*, 59(5):469–478, 2004.
- [18] Min Mun, Sasank Reddy, Katie Shilton, Nathan Yau, Jeff Burke, Deborah Estrin, Mark Hansen, Eric Howard, Ruth West, and Péter Boda. Peir, the personal environmental impact report, as a platform for participatory sensing systems research. In *Proceedings of the 7th international conference on Mobile systems, applications, and services*, pages 55–68. ACM, 2009.
- [19] Carlos Nunes, Ana Margarida Pereira, and Mário Morais-Almeida. Asthma costs and social impact. *Asthma research and practice*, 3(1):1, 2017.
- [20] National Institutes of Health. National institutes of health, 2017. <https://www.nih.gov>.
- [21] Karl Pearson. Notes on the history of correlation. *Biometrika*, 13(1):25–45, 1920.
- [22] PropellerHealth. Propeller, 2017. <https://www.propellerhealth.com>.
- [23] Chetanya Puri, Arijit Ukil, Soma Bandyopadhyay, Rituraj Singh, Arpan Pal, and Kayapanda Mandana. icarma: Inexpensive cardiac arrhythmia management—an iot healthcare analytics solution. In *Proceedings of the First Workshop on IoT-enabled Healthcare and Wellness Technologies and Systems*, pages 3–8. ACM, 2016.
- [24] Qualtrics. The leading research experience software, 2018. <https://www.qualtrics.com>.

- [25] Ho-Kyeong Ra, Asif Salekin, Hee-Jung Yoon, Jeremy Kim, SM Shahriar Nirjon, David J Stone, Sujeong Kim, Jong-Myung Lee, Sang Hyuk Son, and John A Stankovic. Asthmaguide: an asthma monitoring and advice ecosystem. In *Wireless Health*, pages 128–135, 2016.
- [26] C Carl Robusto. The cosine-haversine formula. *The American Mathematical Monthly*, 64(1):38–40, 1957.
- [27] Kimiko Ryokai, Florian Michahelles, Mareike Kritzler, and Suhaib Syed. Communicating and interpreting wearable sensor data with health coaches. In *Pervasive Computing Technologies for Healthcare (PervasiveHealth), 2015 9th International Conference on*, pages 221–224. IEEE, 2015.
- [28] G Sawyer, J Miles, S Lewis, P Fitzharris, N Pearce, and R Beasley. Classification of asthma severity: should the international guidelines be changed? *Clinical and Experimental Allergy*, 28(12):1565–1570, 1998.
- [29] Sagar Sharma, Keke Chen, and Amit Sheth. Toward practical privacy-preserving analytics for iot and cloud-based healthcare systems. *IEEE Internet Computing*, 22(2):42–51, 2018.
- [30] Amit Sheth, Pramod Anantharam, and Krishnaprasad Thirunarayan. khealth: Proactive personalized actionable information for better healthcare. In *Workshop on Personal Data Analytics in the Internet of Things (PDA@ IOT 2014), collocated at VLDB*, 2014.
- [31] Amit Sheth, Utkarshani Jaimini, Krishnaprasad Thirunarayan, and Tanvi Banerjee. Augmented personalized health: How smart data with iots and ai is about to change healthcare. In *Research and Technologies for Society and Industry (RTSI), 2017 IEEE 3rd International Forum on*, pages 1–6. IEEE, 2017.

[32] World Health Organization: WHO. Asthma fact sheet, November 2017. <http://www.who.int/mediacentre/factsheets/fs307/en>.